



Model OG-75 thru OG-750 Oxygen Generator

Installation, Operation &
Maintenance Manual



OG-100

Oxygen Generating Systems International

814 Wurlitzer Drive
North Tonawanda, New York 14120
Telephone - (716) 564-5165
Fax - (716) 564-5173
Toll Free - (800) 414-6474
E-mail - ogsimail@ogsi.com
Web Site - <http://www.ogsi.com>

Table of Contents

Topic	Page Number
<u>General Information:</u>	
- Unpacking Instructions	1
- Technical Service and Assistance	2
- Warranty Policy	3
- Limits of Liabilities	4
- Operational Warnings	4
- Safe Handling of Compressed Gas Cylinders	5
- Pressure Swing Adsorption (PSA) Technology	6
- OG-75 thru OG-750 Specifications	7
- Required Operating Conditions	8-9
- Typical Setup Diagrams	10
<u>Operating Instructions:</u>	
- Pre-installation Check	11
- Sieve Re-packing Diagram	12
- Type 1 Switch Connection Diagram	13
- Type 2 Switch Connection Diagram	14
- Setup Instructions	15-16
- Safety Precautions	17
- Start Up Procedures	18-19
- Shut Down Procedures	20
- Troubleshooting Guide	21
- Detailed Warning Description	22
<u>Component drawings/description:</u>	
- Process Flow Schematic	23
- Process Flow Schematic: Touchscreen Option	24
- Process Flow Description	25
- External Components Drawing	26
- External Components Description	27-29
- Internal Components Drawing	30
- Internal Components Description	31-32
- Touchscreen General Introduction	33-34
- Individual Touchscreen Descriptions	35-46
- Manifold Drawing	47
- Manifold Operating Procedures	48
<u>Maintenance Instructions:</u>	
- Routine Maintenance	49
- Long Term Maintenance	49
- Filter Element Replacement Instructions	50

©2003, **OGSI**. All rights reserved. **OGSI** is a registered trademark. This publication may not be reproduced in part or whole without written permission of **OGSI**.

Unpacking Instructions

The crate should be opened and inspected immediately upon delivery. If the exterior of the crate is noticeably damaged at the time of delivery, make a note on the freight bill before signing it. Unpack the unit at once and perform a visual inspection to determine if it is dented, bent or scratched. Also check to make sure the power cord is attached and that the control panel has not been damaged in any way during shipment.

Do not discard the shipping crate. If for any reason the unit should need to be returned in the future the user will be responsible for packaging the unit to the same degree that it was received from OGSi to ensure its undamaged arrival at OGSi.

If any damage is discovered during the initial visual inspection, call the Freight Company immediately. ***This must usually be done within 24 hours of delivery.*** Claims of damage due to freight handling can only be filed by you, the consignee, as **OGSi** shipping terms are Free On Board (FOB), North Tonawanda, NY USA. This means that once the equipment leaves our dock you are the owner of it. **OGSi** has no legal claim to make against any shipping company for damage.

At **OGSi**, we are committed to using shipping companies with good reputations for taking care in the handling of freight and providing service in the event of damage. When you call OGSi for your Return Authorization Number please ask us about preferred shipping companies.

Technical Service and Assistance

This manual is intended as a guide for operators of **OGSI** Oxygen Generators and Oxygen Generating Systems. It includes information on our warranty policy, on how the machines work, on proper set up and operation, and finally on how to maintain them.

It is our intention to provide complete customer satisfaction. This manual is one way in which we hope to provide you with technical assistance.

If you do not find what you need in this manual or you have other questions about this equipment, please feel free to contact us directly. This can be done in a number of ways that are listed below. We look forward to serving your oxygen needs and invite your inquiries. We will respond to you as promptly as possible.

Technical service personnel are available at **OGSI** from 8:00 A.M. through 5:00 P.M. Eastern (U.S.) Standard Time which is Greenwich Mean Time minus 5 hours (GMT - 5). You may reach **OGSI** personnel through the following means:

- **By Telephone from within the United States** two numbers may be used:
 - (800) 414-6474 - our toll free number (from within the USA only)
 - (716) 564-5165 - our direct number
- **By Telephone from outside the United States** you must dial:
 - Your local International Access Code (usually 0 or 00), followed by
 - The Country Code for the U.S. which is (1), followed by
 - Our Area Code and Number (716) 564-5165
- **By Automated Voicemail:**
 - at the numbers listed above -available 24 hours/day.
- **By Fax from within or outside the United States** as above at:
 - (716) 564-5173 - available 24 hours/day
- **By E-Mail or through our World Wide Web site** at:
 - ogsimail@ogsi.com - available 24 hours/day
 - <http://www.ogsi.com> - available 24 hours/day
- **By Mail** at:
 - OGSI**
 - 814 Wurlitzer Drive
 - North Tonawanda, New York 14120 USA
- **By UPS, FedEx or Common Carrier** at: *(This address for return shipments)*
 - OGSI**
 - 814 Wurlitzer Drive
 - North Tonawanda, New York 14120 USA

We also have a list of Distributors and Authorized Service Agents available upon request.

Warranty

Oxygen Generating Systems, International (hereinafter **OGSI**) provides a warranty on its products against defects in material and workmanship, under normal use and operation, as applicable in the statements below.

The **OGSI** Warranty provides the following:

- a.) Free replacement of the product where defects in the material and/or workmanship are evident at the time of delivery, **EXCLUSIVE** of shipping damages. **OGSI** will pay shipping both ways. **(If shipping damage is evident, contact shipper immediately).**
- b.) Free repair or replacement of product (excluding filter elements) where defects in material and/or workmanship become evident between the time of shipment and one (1) year from the date of shipment. **OGSI** will pay shipping one (1) way.

Note - *A Return Authorization Number must be obtained from **OGSI** prior to return shipment of equipment*

These warranties shall also become null, void and not binding on **OGSI** if a defect or malfunction occurs in the product or any part of the product as a result of:

- a.) A failure to provide the Required Operating Conditions (see page 9)
- b.) Repair, Attempted Repair, Adjustment or Servicing by anyone other than an authorized representative of **OGSI**
- c.) External Causes

Molecular Sieve Replacement:

The breakdown of the molecular sieve inside the generator (dusting of the sieve) only occurs if excess water/oil are entrained in the feed air stream. Under no circumstances is molecular sieve covered under warranty by **OGSI**. If sieve dusting occurs on your machine, check the air compressor, air dryer and filter elements.

This warranty may be transferred to subsequent owners of a given machine only with the prior approval of **OGSI**. The warranties above are given expressly in lieu of any other warranty stated or implied and constitute the only warranties made by **OGSI**.

Limits of Liability

OGSI shall not be liable for any special, indirect, incidental or consequential damages resulting from the use, or as a result of the malfunction of an Oxygen Generator.

In the event the buyer or leasee chooses to use the **OGSI** oxygen generator for medical or human life purposes, **OGSI** will not be liable for any special, indirect, incidental, or consequential damages resulting from such use.

Operational Warnings

OGSI Oxygen Generators are self-contained systems for the production of high concentration oxygen. Although oxygen itself is not combustible, it can be very dangerous. It greatly accelerates the burning of combustible materials.

- Precautions should be taken to avoid a fire in the area of the generator.
- Smoking should not be permitted in the area where the generator is located.
- All oxygen connections and hoses should be kept clean and free of grease, oil and other combustible materials.
- Valves controlling oxygen flow should be opened and closed slowly to avoid the possibility of fires or explosions that can result from adiabatic compression.
- When bleeding a tank or line, stand clear and do not allow oxygen to embed itself within clothing. A spark could ignite the clothing violently.
- High-pressure gasses may be present within the system. Valves should be opened and closed slowly, and safety glasses and hearing protection should be worn at all times while gasses are being vented.
- Do not attempt to modify or enhance the performance of a Generator in any way.

Safe Handling of Compressed Gas Cylinders

Many of the following procedures for the handling, storage, and utilization of compressed gas in cylinders are taken from material furnished by the Compressed Gas Association, which complies with OSHA standards.

- If visual inspection indicates obvious damage, the cylinder should be returned to the supplier without any attempt at using the machine.
- If a cylinder leaks, other than normal venting, and the leak cannot be corrected by tightening a valve gland or packing nut, the valve should be closed and a tag attached stating that the cylinder is not serviceable. Remove the cylinder outdoors to a well-ventilated or open area, notify the supplier, and follow the supplier's instructions for the return of the cylinder.
- Keep the cylinder valve closed at all times except when in active use. When removable caps are provided for valve protection, they should not be removed except for active use. Remember to replace removable caps when not in use.
- Do not place cylinders in a position where they might become part of an electric circuit. When electric welding is taking place, precautions should be taken to prevent accidental grounding of cylinders, permitting them to be burned by electric welding arc.
- Cylinders should not be dropped or permitted to strike each other or any other surface. Do not drag or slide cylinders; use a suitable hand truck, fork truck, roll platform or similar device, firmly securing the cylinders for transporting.
- Always ensure that compressed gas cylinders be securely strapped or chained in place to prevent tipping or falling. Do not store near elevators, stairs, or passageways.
- Do not store oxygen cylinders with flammable gas cylinders. Stored oxygen and fuel gas cylinders should be at least 20 feet apart; preferably separated by a fire resistant partition.
- For additional information refer to the CGA publications that can be found at <http://www.cganet.com>
- See also ISO publication 10083, available by request at OGS, or online at <http://www.iso.ch>

Pressure Swing Adsorption (PSA) Technology

The **OGSI** Oxygen Generator is an on-site oxygen-generating machine capable of producing oxygen on demand in accordance with your requirements. It requires less than 600 Watts of electrical power to control its operation.

In effect, it separates the Oxygen (21% of air) from the air it is provided and returns the Nitrogen (78% of air) to the atmosphere through a waste gas muffler. The separation process employs a technology called Pressure Swing Adsorption (PSA). At the heart of this technology is a material called Molecular Sieve.

This Molecular Sieve is an inert, ceramic-like material that is designed to adsorb Nitrogen more readily than Oxygen. Each of the two beds that make up the generator contain this sieve. As air is fed into one of the beds, the sieve in that bed holds the Nitrogen to it and allows the Oxygen to flow through it and out to the surge tank as product gas. Eventually the sieve becomes saturated with Nitrogen. When this occurs, the feed air is directed to the other bed where the oxygen production/separation process continues. While the second bed is being fed air, the first is depressurized and safely releases the Nitrogen it has trapped through the waste gas muffler. This regenerates the sieve in the first bed and prepares it to accept feed air again continuing the process. The two beds continue to work in this alternating fashion to provide a continuous supply of Oxygen.

This air separation process is reliable and virtually maintenance free. The Molecular Sieve will last indefinitely, as long as it does not become contaminated with water and oil vapors. This is why regular filter element replacement is critical to trouble free operation. The filter elements are very inexpensive, semi-annual maintenance.

OG-75 Thru OG-750 Oxygen Generator Specifications

Model	Oxygen Output		Air Required		Power
	*SCF/Hour	**NM ³ /Hour	SCF/Minute	NM ³ /Minute	Watts/Hour
OG-75	75	2.0	17	0.45	120
OG-100	100	2.6	22	0.58	120
OG-175	175	4.6	32	0.84	120
OG-250	250	6.6	45	1.18	120
OG-375	375	9.9	68	1.78	120
OG-500	500	13.1	88	2.31	120
OG-650	650	17	118	3.10	120
OG-750	750	19.7	133	3.50	120

Model	Dimensions (D x W x H)		Weight	
	Inches	Centimeters	Pounds	Kilograms
OG-75	21 x 21.5 x 67	53 x 54 x 170	310	141
OG-100	24 x 24 x 69	61 x 61 x 175	500	227
OG-175	25 x 26 x 72	64 x 66 x 183	775	351
OG-250	26 x 32 x 72	66 x 81 x 183	1100	499
OG-375	30 x 36 x 84	76 x 91 x 213	1350	612
OG-500	36 x 48 x 83	91 x 122 x 211	1800	816
OG-650	48 x 55 x 83	122 x 140 x 211	2400	1625
OG-750	38 x 52 x 88	97 x 132 x 224	2600	10888

The Oxygen Purity Specification is 93% (\pm 3%) for all models.
 The Minimum Feed Air Pressure Required is 90 PSIG (621 kPa) for all models.
 The Minimum Oxygen Pressure Delivered is 45 PSIG (310 kPa) for all models.
 For domestic models the Power Configuration is 110 VAC/60 Hz, for export models 220 VAC/50 Hz.

* - A Standard Cubic Foot (SCF) is a cubic foot of gas at 14.7 psia (sea level atmospheric pressure) and 60 degrees Fahrenheit

** - A Normal Cubic Meter (NM³) is a cubic meter of gas at 760 mm-Hg (sea level atmospheric pressure) and 0 degrees Celsius

Required Operating Conditions

Location of Machine: The standard Oxygen Generator is intended for use indoors. It comes with a NEMA 12 enclosure box, which provides a degree of protection against dust, falling dirt and non-corrosive liquids. A NEMA 4X enclosure package is optionally available if outdoor location is required. The NEMA 4X package will provide a degree of protection against corrosion, windblown dust and rain and splashing or hose-directed water.

Feed Air/Ambient Air Quality: The useful life expectancy of any PSA Oxygen Generator is directly related to the air quality that is fed into it. Hot, humid, dirty, oily air deteriorates and degrades the performance of molecular sieve. In order to preserve the effectiveness and extend the useful life of the generator, all precautions should be taken to insure that Cool, Dry, Clean, Oil-Free air is provided to it.

Changing the inlet air filter is a simple and easy way to provide the unit with some protection. Where possible, it would be advantageous to locate the unit in an air-conditioned space, or at least a well-ventilated area. The room should also be free of toxic gases and high concentrations of hydrocarbons, especially carbon monoxide. Additionally, to the degree possible, humid, oily areas should be avoided as installation sites.

Ambient Air Temperature: The machine is designed for use over a temperature range of 40°F to 100°F (5°C to 38°C). Since hot air has the ability to hold much more water, in the form of humidity, than cool air, operating the units in hot areas will reduce the effective life of the molecular sieve.

Note: Operation outside of this temperature range will not be warranted by **OGSI**.

Feed Air Requirements:

The pressure of the incoming feed air supply should be at least 90 PSIG (620 kPa). Pressure below this level will not allow the machines to run at the oxygen purity, production capacity and efficiency levels they were designed to meet.

The compressed air that is fed into the Oxygen Generator should be no hotter than 100°F (38°C). Air temperatures higher than this will immediately reduce the efficiency of the machines and can damage the molecular sieve over time. Hot air is also able to hold much more water than cool air and water ruins sieve.

The use of aftercoolers on feed air compressors and refrigerated air dryers between the air compressor and the oxygen generator is highly recommended and will improve the performance and lifetime of the oxygen generator.

Pipe scale, oil carryover from the compressor and water vapor should all be minimized to ensure long and trouble-free Oxygen Generator operation. These things can be accomplished with a few regular procedures. First, it is important to recognize that the air compressor is a critical component in the Oxygen Generating process. It needs to be maintained in accordance with the instructions provided in its operating manual. Second, condensation needs to be removed from the air receiver tank and air distribution lines at regular intervals to keep it from flowing into the generator. Finally, as already mentioned in a few areas, the filter element inside the Oxygen Generator needs to be replaced every six months.

Electrical Power: On U.S. models, the power for the control circuitry of the Oxygen Generator is a single-phase electrical supply of 120 Volts AC and less than 1 Amp at a frequency of 60 Hz. This equates to fewer than 120 Watts of power.

On Export models, the power for the control circuitry of the Oxygen Generator is a single-phase electrical supply of 220 Volts AC and less than 500 milliAmps (0.5 Amps) at a frequency of 50 Hz. This also equates to less than 120 Watts of power.

Positioning: The unit must be operated in an upright position only, with no obstruction blocking airflow around the unit.

Typical Setup Diagrams

Shown immediately below is a sample drawing that depicts how a typical system could look when connected.

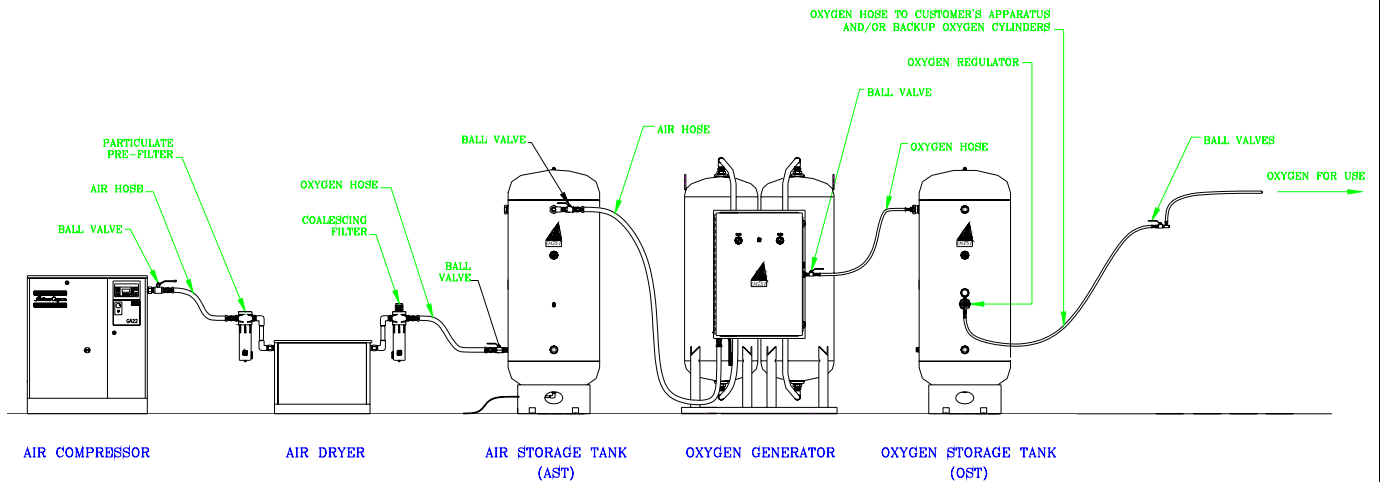

Occasionally a user may choose to maintain a liquid or cylinder backup and keep it connected to his system for critical applications. This is a precaution that ensures uninterrupted oxygen flow if the power supply should be lost or the compressor or generator malfunction.

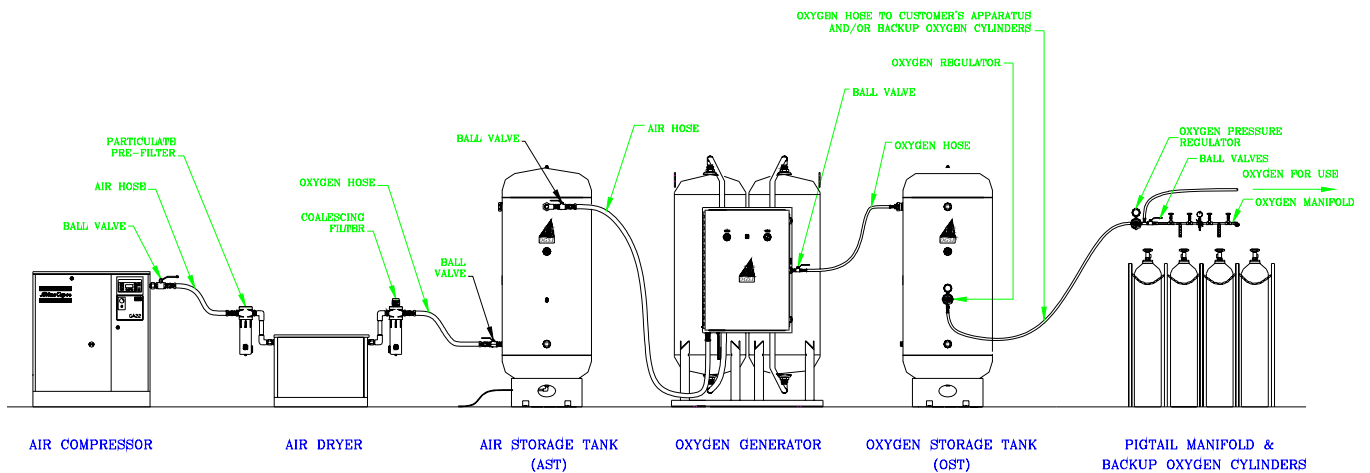

Pre-Installation Check Instructions

Although every Oxygen Generator is thoroughly tested and checked before it is shipped from our factory, the following checks are necessary to insure that none of the internal components have been damaged in shipment. This check should take less than five minutes to perform.

- 1.) Make a visual inspection of the machine and make sure all parts are properly attached.
- 2.) Sieve settles during shipment, therefore it is important to re-pack the supplied sieve to the top of the sieve beds making sure no empty voids are left in the beds. The sieve can be harmed by exposure to air and caution must be taken to keep the sieve in the oxygen generator & the container sealed as much as possible. (See page 12 for diagram.)
- 3.) The ON/CONTINUOUS/AUTO switch will need to be attached to the enclosure door. (See page 13 or 14 for a diagram depending on the type of switch you have.)
- 4.) These checks are for machines with the touchscreen option:
 - a. Ensure the touch screen is powered, and a display is visible. Consult the troubleshooting guide in this manual (see page 14) for any problems encountered.
 - b. After selecting a language and entering a password, start the machine by pressing both the **OPERATING MODE** (Automatic), and then the **ON/OFF** pushbuttons.

Sieve Re-packing Diagram

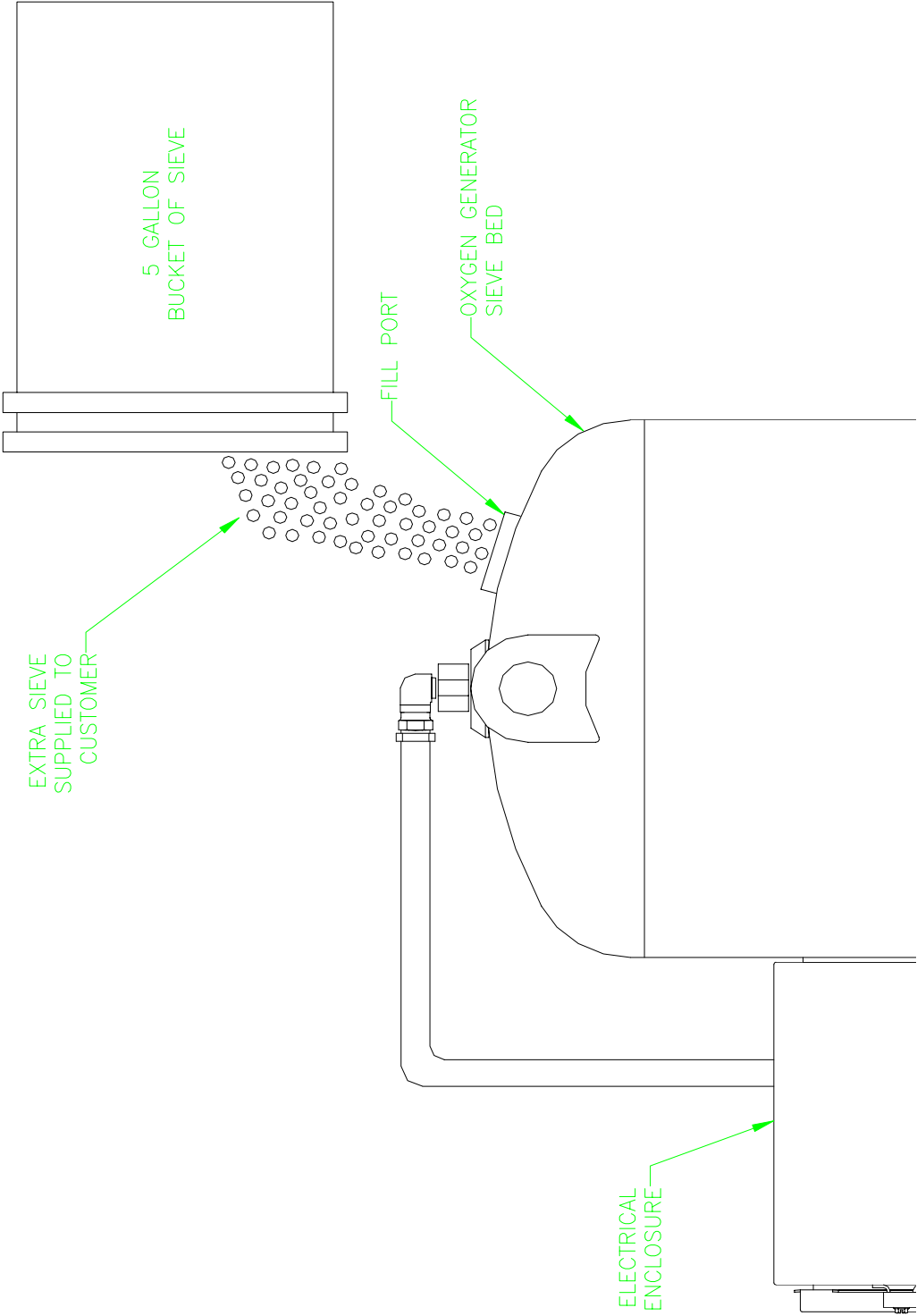

Type 1 Switch Connection Diagram

SWITCH ASSEMBLY INSTRUCTIONS

- 1-TAKE #1 AND PUSH THROUGH #7
- 2-NOW TAKE #1 & #7 AND PUSH THROUGH THE FRONT OF THE ENCLOSURE DOOR
- 3-NEXT TAKE #6 AND PUSH ONTO #1 FROM THE BACKSIDE OF THE ENCLOSURE DOOR
- 4-NOW HAND TIGHTEN #5 ONTO #1 FROM THE BACKSIDE OF THE ENCLOSURE DOOR
- 5-AFTER THIS PUSH #3 INTO #1 FROM THE BACKSIDE OF THE ENCLOSURE DOOR
- 6-NOW PUSH #4 INTO THE LOCKED POSITION (SEE FRONT VIEW)
- 7-NOW TAKE #2 AND PUSH ONTO #4 TO SECURE IT IN THE LOCKED POSITION

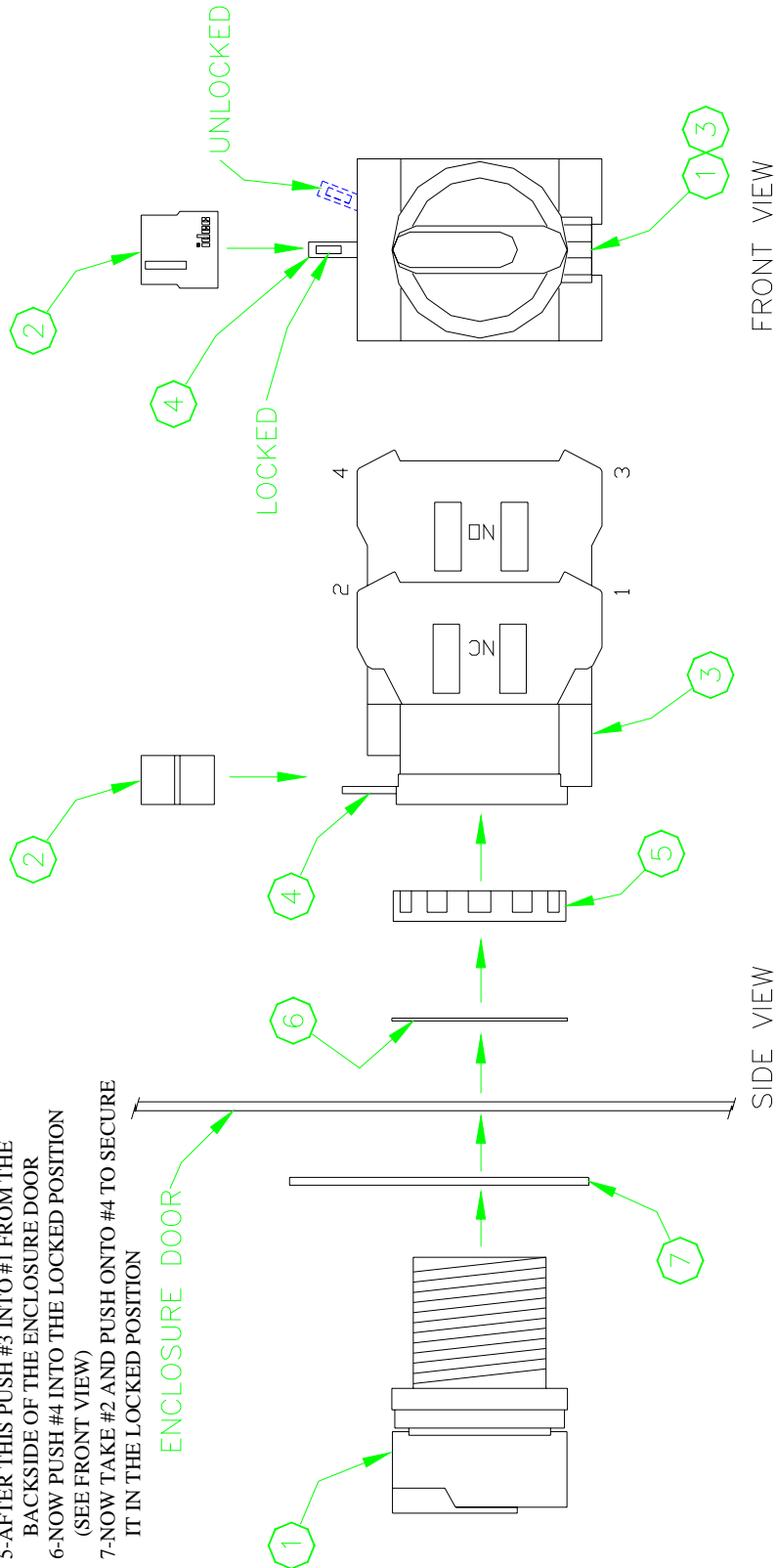

Type 2 Switch Connection Diagram

SWITCH ASSEMBLY INSTRUCTIONS

- 1-TAKE #1 AND PUSH THROUGH #4
- 2-NOW TAKE #1 & #4 AND PUSH THROUGH THE FRONT OF THE ENCLOSURE DOOR
- 3-PUSH #2 ONTO #1 AND TURN IT TO LOCK THEM TOGETHER
- 4-NOW MAKING SURE THE ASSEMBLED PARTS ARE STRAIGHT TAKE A SCREW DRIVER AND TIGHTEN BOTH #3's

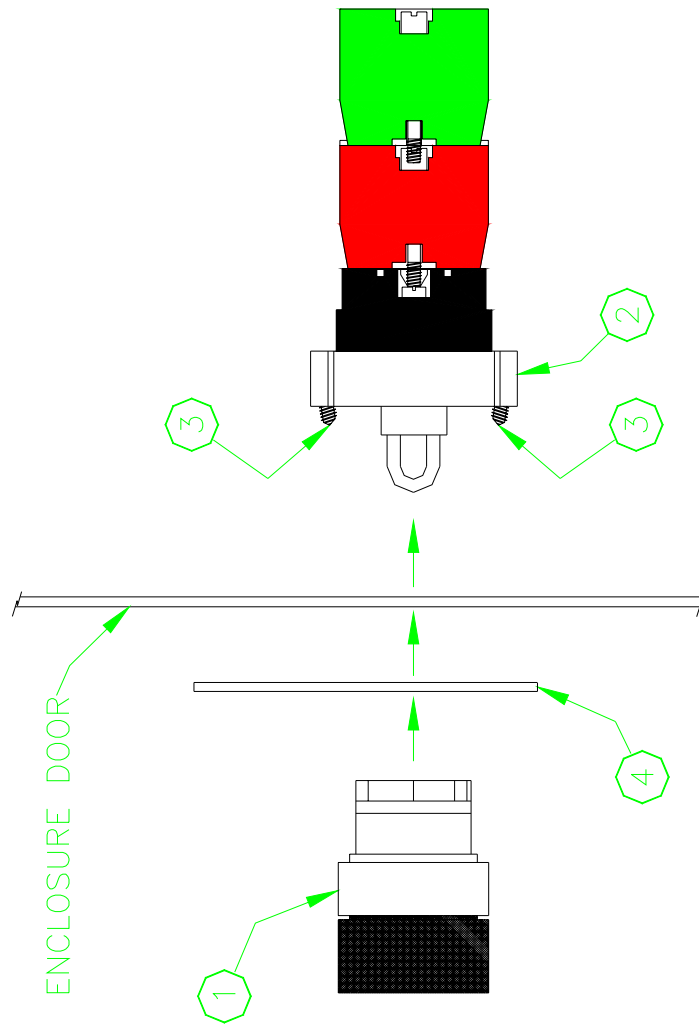

Setup Instructions

These instructions are intended as a general guideline for a typical system installation. If you feel you have an unusual situation or would like additional assistance in determining the appropriateness of a particular setup, please do not hesitate to contact us. *See Page 2 for details on how that can be done.*

1.) Connect a Ball Valve Between Your Air Supply and the Feed Air (Black) Hose Provided -

This valve will be used to shut off the air supply to the generator for filter replacement. If you do not have a valve on hand at this time, skip this step as one can be installed at this point at a later date.

OGSI does stock valves that can be used for this purpose. If you need one you can reach our sales department at (716) 564-5165.

2.) Connect the Feed Air to the Ball Valve Mentioned Above (or directly to) Your Air Supply and to the Left Side of the Generator -

On systems this size, a hose is not included as installation setups vary greatly. The left side of the generator has a fitting that is labeled 'Air In'. This fitting will be either a 37°-flared JIC fitting or a male pipe thread depending on which model you have. Connections to these are readily available worldwide through the Parker distribution network or from **OGSI**.

3.) Unroll and Direct the Filter Drain (Clear) Hose into a Bucket or Floor Drain (if available) -

This drain hose is provided with each unit and can be used to alleviate the potential problem of having water and material trapped by the filter blown directly on to the floor. If this hose is not going to be used it should be disconnected from the machine and discarded.

4.) Connect the Oxygen (Green) Hose to the Oxygen Outlet Connection on the Right Side of the Generator and to the Oxygen Storage Tank -

The green hose is the Oxygen hose. The Oxygen Outlet Connection is on the right hand side of the machine and is Labeled 'O₂ Out'. This Oxygen Hose has threaded fittings that swivel on each end of it. Either side can be connected to the generator, as the fittings are the same on each end.

If your storage tank was purchased from **OGSI**, it will have an appropriate fitting in place for this connection. It will be attached to the same tee fitting that holds the safety relief valve. If the tank was not purchased from **OGSI**, you must insure that it has the appropriate size fitting to accept this hose assembly.

***OGSI** can provide these fittings, if necessary.*

5.) Connect Your Oxygen Hose to the Oxygen Pressure Regulator on the Oxygen Storage Tank -

If you are using an Oxygen Manifold as in one of the previous drawings, we recommend another ball valve between the hose that is connected to the Oxygen Regulator and the Oxygen Manifold. This Ball Valve can then be used as your primary supply or shut off valve between the generator and your application. Closing this valve nightly before turning the generator off will ensure that the storage tank is full the next day.

As before, this Oxygen Hose and Ball Valve are not included with the generator because the connections used from location to location can vary greatly. We can provide these Ball Valves and Hose Assemblies, if required, but intentionally do not include them with every machine so that we may provide you with the best price for the basic package.

6.) Plug the Electrical Cord into an Outlet -

It is preferable that the outlet used be one that cannot be accidentally turned off. Generators shipped within North America can be plugged into any typical 110 Volt outlet while those shipped outside North America will typically be wired to accept a single phase 220 Volt supply.

Once connected you should be ready to begin to produce your own Oxygen.

Safety Precautions

It is very important that you read the precautions below and make yourself aware of the hazards of oxygen in general. While it can be handled and used very safely it can also be mishandled or applied incorrectly causing dangerous situations.

1.) **Oxygen is a fire hazard.** It can be very dangerous as it vigorously accelerates the burning of combustible materials. To avoid fire and/or the possibilities of an explosion, oil, grease or any other easily combustible materials must not be used on or near the oxygen generator. Smoking, heat and open flames are also not recommended near the unit. Individuals who have experience handling oxygen systems should become the designated operators of the oxygen generator within your facility.

2.) **Ensure that the oxygen outlet stream is not directed toward anyone's clothing.** Oxygen will embed itself in the material and one spark or hot ash from a cigarette could ignite the clothing vigorously.

3.) In critical applications it is important to have a backup supply of oxygen, as it should be remembered that the generator does not come with any reserve storage tank and it does require electrical power to operate. Therefore **during power outages oxygen will not be produced.**

4.) As previously mentioned, **do not use extension cords to bring power to the generator.** The current draw into the unit is high and could overheat some extension cords. It is also important to use only a properly grounded outlet.

5.) **High Pressure Oxygen may present a Hazard.** Always follow proper operating procedures, and **open valves slowly.** Rapid pressurization may result in personal injury. Safety glasses and hearing protection are required when venting oxygen under high pressure.

Start Up Procedures

Prior to attempting to run the Oxygen Generator it is important to check to connections that have been made to it. Make sure that they are all tight as leaks will be detrimental to the generator's performance and increase your operating expenses.

Also be sure to review the 'Setup Instructions' (pages 15-16) before starting the unit to be sure that all connections have been made properly. If your system does not respond as described below check the contact our facility for possible causes and fixes.

1.) Start Your Air Compressor -

Allow it fill its surge tank to at least 90 PSIG (620 kPa) before starting the generator.

2.) Open the Ball Valve that Supplies Air to the Generator (if you have one in place) and Check the Regulated Feed Air Pressure Gauge (on the left side of the Generator) -

The regulated feed air pressure gauge should read about 70 PSIG (480 kPa).

3.) Turn the Generator Control Switch to 'Continuous' -

This turns the unit on and begins the generation process. The light inside the switch will always be on as well. For the first 5 seconds the filter bowl drain will open and condensation or material trapped in the bowl will be blown out the drain valve on the bottom of the cabinet. If after 5 seconds air is not blowing out the filter drain, then manually depress the filter drain push button on the lower left-hand side of the cabinet until the bowl is completely empty of fluid. This drain will vent for 5 seconds every 15 minutes while the unit is operating.

If this is the first time the generator is being run or it has not run for a few days, the Oxygen Storage tank will be full of air. Oxygen will fill the tank but since it is being mixed with the air that was trapped in it at the start of operations the oxygen purity will be less than optimal. This problem is easily corrected and can be avoided in the future if proper shut down procedures are used.

To correct this allow the surge tank to reach 50 PSIG (345 kPa) (the gauge on the right side of the machine will indicate storage tank pressure). This will take only a few minutes depending on the production capacity of the generator and storage tank size you have. Once this pressure is reached vent oxygen from the tank for about 5 minutes or until the storage tank pressure drops to about 40 PSIG (280 kPa).

Caution: While Venting the Tank Make Sure There Is No Smoking Or Open Flame within 10 Feet of the Generator and Do Not Allow Venting Oxygen To Come In Contact With Any Clothing!!

After venting the tank the switch can be turned to 'Automatic'.

4.) If the Storage Tank Pressure is Above 30 PSIG (210 kPa), the Generator Switch can be Immediately Turned to 'Automatic' -

This should be the case upon arriving in the morning to a system that was properly shut down the evening before or after starting up the first time and having vented the storage tank down to 40 PSIG (280 kPa).

The generator will now fill the tank to about 60 PSIG (420 kPa) and then remain in a standby mode until the storage tank pressure drops to about 45 PSIG (310 kPa). It will then begin to cycle again attempting to keep the storage tank pressure between 45 PSIG (310 kPa) and 60 PSIG (420 kPa). While in this mode, the light inside the control switch will be on whenever the unit is cycling.

5.) Open the Valve that Allows Oxygen to Flow to Your Manifold or Application -

This valve, although not included in our standard accessory package, should be in place to ensure a proper shut down and avoid the possibility of wasting oxygen through an improperly closed torch valve.

6.) If An Average Oxygen Pressure Greater than 45 PSIG (310 kPa) is Required or Demand is at a Peak -

It would be preferable to run in the continuous mode. Please keep in mind that our specification for the maximum oxygen pressure available from a system is 45 PSIG (310 kPa). Pressures higher than 45 PSIG (310 kPa) will only be available for short periods of time if Oxygen is drawn from the storage tank at or above the specified production rates for the machines. If the demand is for a higher pressure but a lower flow rate or only for a short period of time up to 60 PSIG (420 kPa) can usually be provided.

Caution: If your application involves metal cutting, welding, brazing, etc. We highly recommend the use of flash guard check valves inserted as close to the torch head in the system as possible.

Shut Down Procedures

Following these few simple steps will allow you to avoid having to run the generator while venting the storage tank every day or every time you want to use it.

1.) Close the Valve that Allows Oxygen to Flow to Your Manifold or Application -This will keep the storage tank from being depressurized while oxygen is not being used.

2A.) Turn the Control Switch to 'Off' -This should really only be done if the storage tank is already pressurized to at least 40 PSIG (280 kPa).

OR

2B.) Leave the Control Switch in the 'AUTO' Position and Allow the Generator to Cycle Until it Refills the Storage Tank to 60 PSIG (420 kPa)-

You will now be ready to go the next day or time you need to use Oxygen.

Note: When in the "AUTO" mode the generator will take approximately 15 minutes to build back up to maximum oxygen purity every time it turns back on causing the average purity in the storage tank to be lower than the maximum purity unless you have the auto-purity option.

Troubleshooting Guide

No Power:

- 1.) Ensure that power is available from the 110 vac supply
- 2.) Visually inspect the electrical wiring. Reconnect any loose wires to their appropriately labeled location.

Oxygen purity is low:

- 1.) Check the system for leaks, using a leak testing solution.
- 2.) Ensure that operating environment is conducive to oxygen generation. Environments with extremely high temperature or humidity will inhibit the system from effectively producing oxygen of high purity.

The following troubleshooting checks are for machines equipped with the optional Touchscreen Control system only

System fails to start:

- 1.) If in manual mode, press the additional start pushbutton.
- 2.) By checking the Gauge Screen, ensure that the current High Oxygen pressure is not greater than the set Low-point.
- 3.) Check the Alarm screen for any faults. A "Warning active" indication should appear at the bottom of each screen if a fault has occurred.

System shuts down inadvertently:

- 1.) Check the alarm screen. If a warning is active follow the instructions.
- 2.) Check the high oxygen pressure gauge. If the reading is equal to the set point, the machine has been programmed to shut down.

Detailed Warning Description

***Thermal switch
Warning
(touchscreen option)-***

The appropriate thermal overload switch must be reset (by pressing it), and the “Clear Warning” pushbutton must be pressed. Normal operation can then be resumed.

***Pressure Switch
Warning
(touchscreen option)-***

If the pressure switch has tripped, this is an indication of the high pressure transducer failure. By design, the high pressure transducer should de-energize the system prior to the pressure switch, which is set to 50 psig higher than the maximum setting for normal system operation. High pressure transducer replacement will be necessary if this fault occurs.

Low Oxygen Pressure-

This may be a result of a leak in the system. Use a leak testing solution to locate and repair any air leaks.

***The machine has
run for 30 minutes and
Purity has not yet been
Reached-***

This may be a result of a leak in the system. Use a leak testing solution to locate and repair any air leaks. (On touchscreen option this warning must be cleared to re-activate the machine.)

***Oxygen purity has
Fallen below
Acceptable limits-***

This may be an indication of a leak within the system. Use a leak testing solution to locate and repair any leaks.

Process Flow Schematic

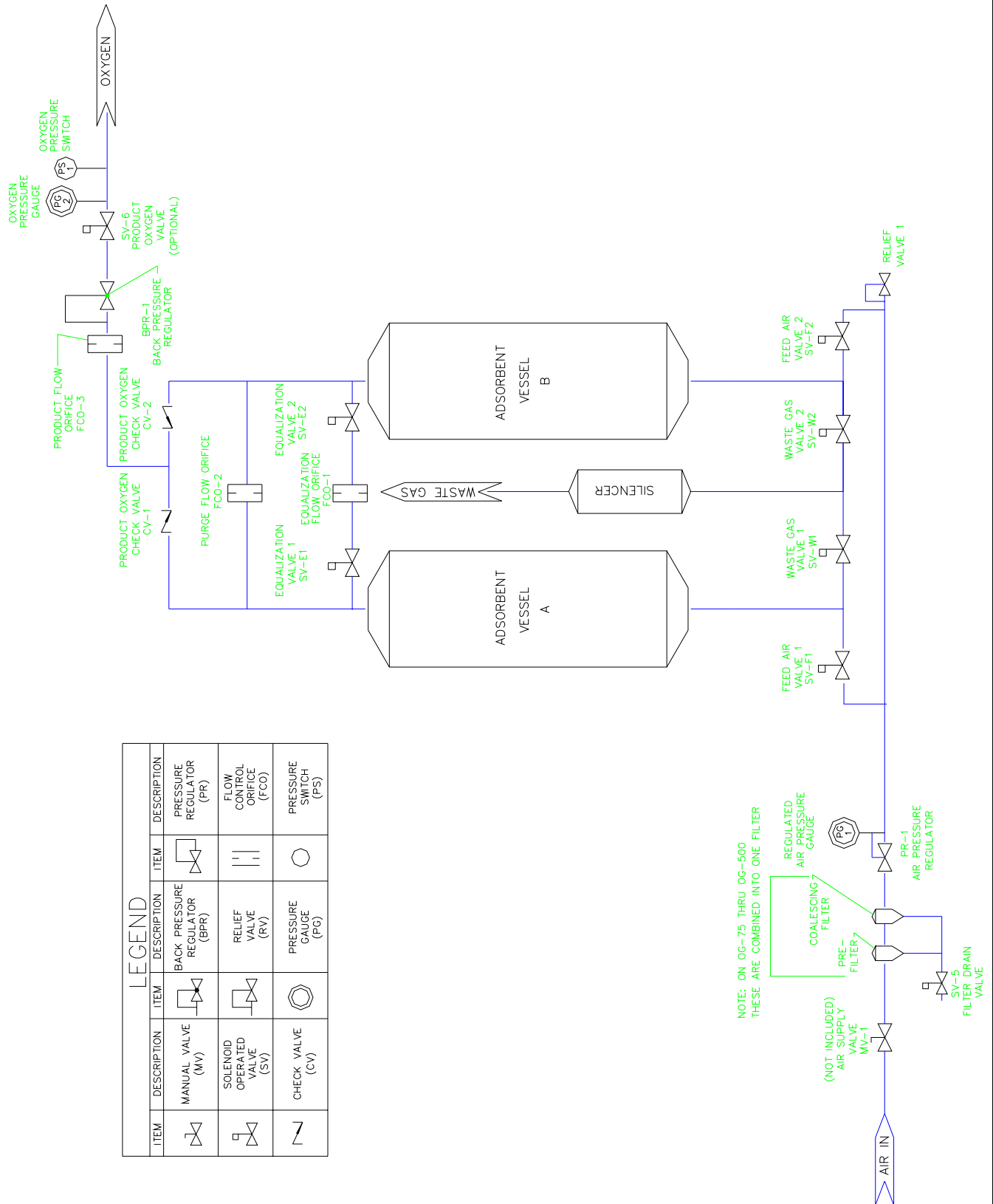

LEGEND			
ITEM	DESCRIPTION	ITEM	DESCRIPTION
	MANUAL VALVE (MV)		BACK PRESSURE REGULATOR (BPR)
	SOLENOID OPERATED VALVE (SV)		RELIEF VALVE (RV)
	CHECK VALVE (CV)		PRESSURE GAUGE (PG)
			FLOW CONTROL ORIFICE (FCO)
			PRESSURE SWITCH (PS)

NOTE: ON OG-75 THRU OG-500 THESE ARE COMBINED INTO ONE FILTER

Process Flow Schematic: Touchscreen Option

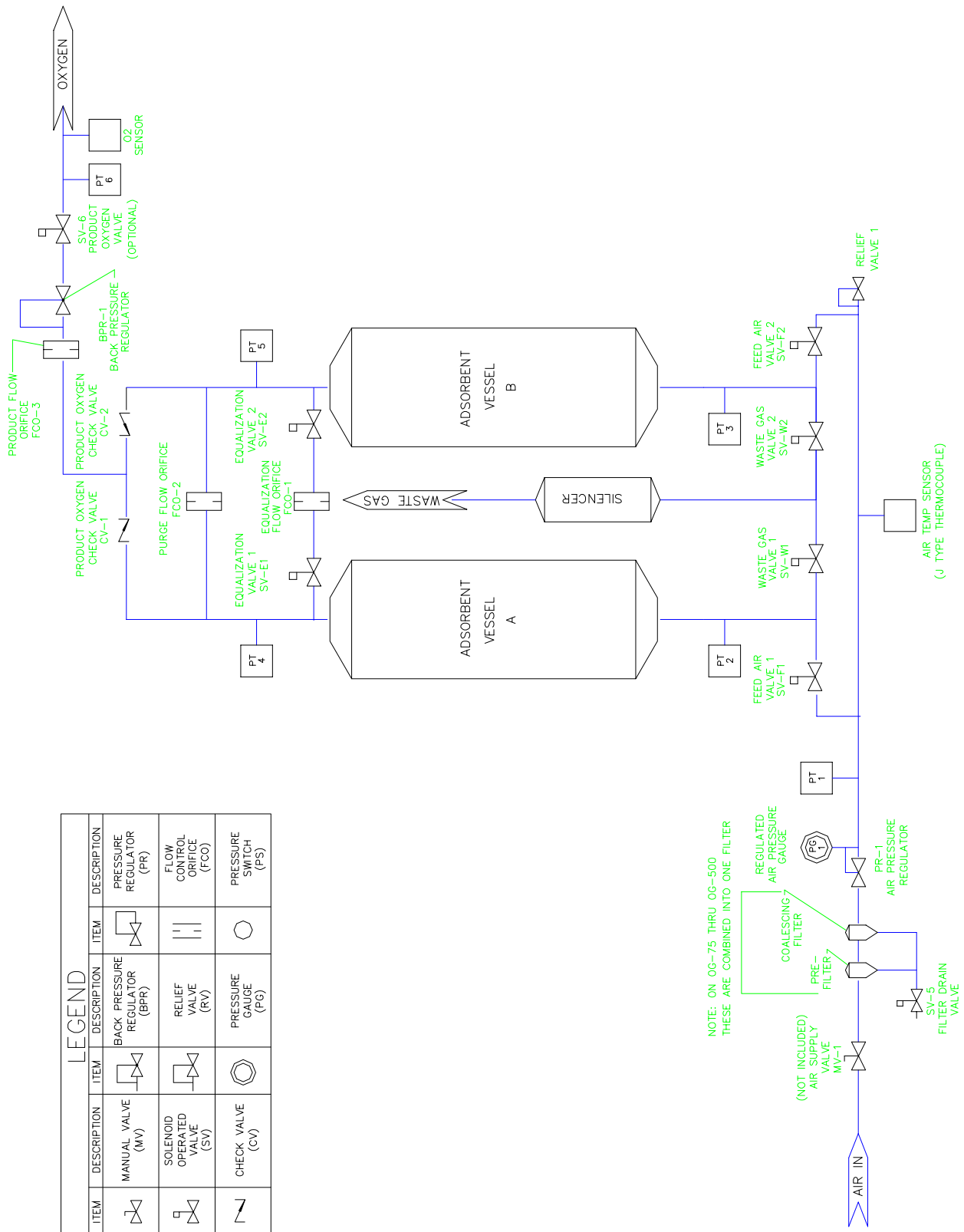

Process Flow Description

The normal flow of air through the Oxygen Generating System is shown on the previous 2 pages in the Process Flow Schematic Drawings. As you can see once the incoming air is filtered and compressed to proper pressure it is directed into one of the two sieve beds. As the air enters the bed, the nitrogen is adsorbed by the sieve and the oxygen passes through as product gas. Each bed produces Oxygen until the sieve in that bed is saturated with Nitrogen. When that occurs, the feed airflow is directed to the other bed, which continues the production process. While the second bed is producing oxygen the first is venting the nitrogen it adsorbed to the atmosphere through a waste gas muffler.

External Components Drawing

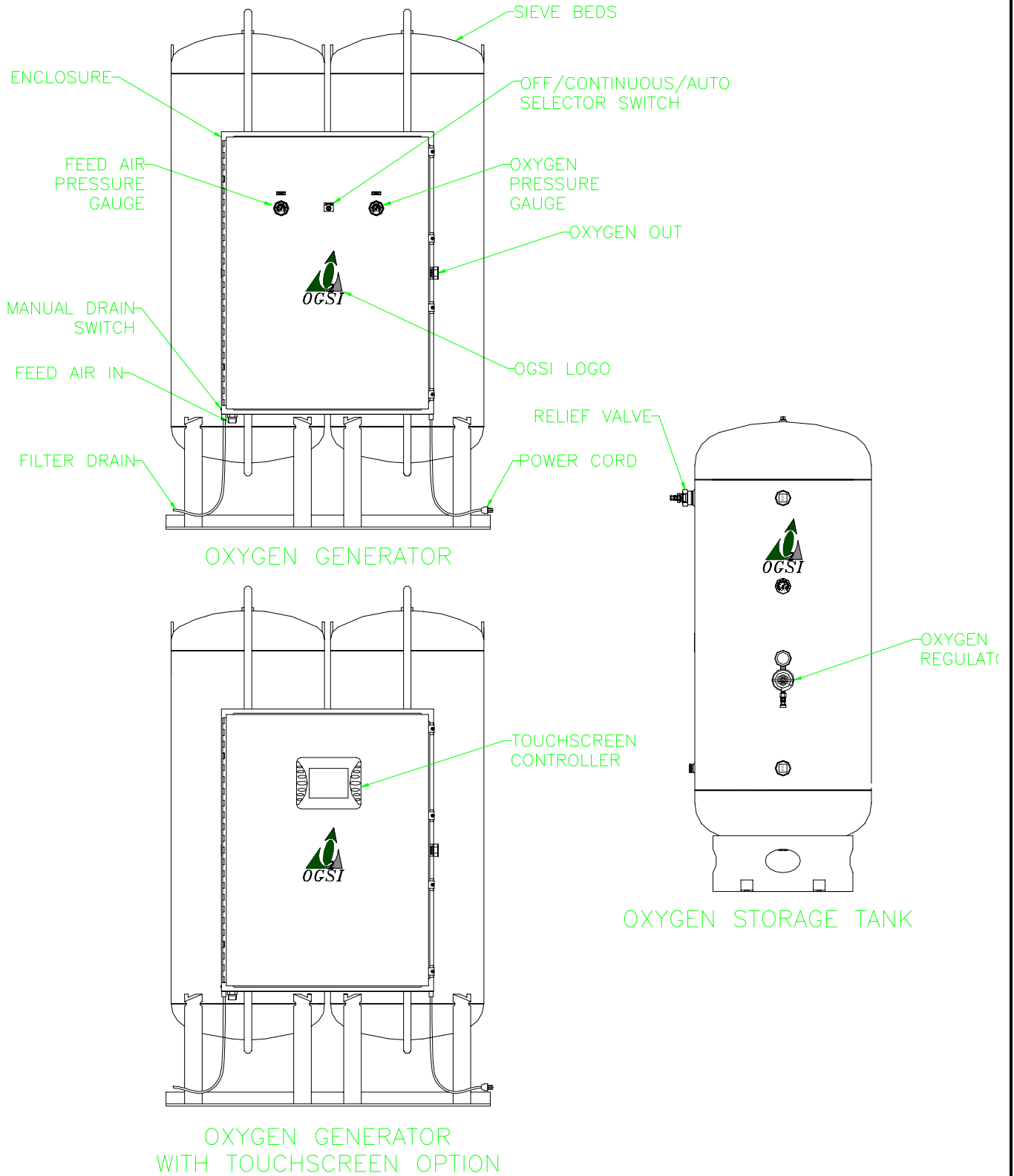

External Components Description

Feed Air In -

This connection is used to supply the feed air to the oxygen generator. It is located on the left side of the machine as you face it. A hose or pipe should be attached to this fitting. It should be of adequate diameter to supply air at a sufficient pressure and flow rate to feed the generator. **OGSI** can assist in sizing this line, if necessary.

Feed Air Pressure Gauge -

This gauge indicates the pressure of the air supplied to the beds after its has been regulated and filtered. While the generator is cycling, this gauge should vary between 35 PSIG and 70 PSIG (240 kPa and 480 kPa).

Off /Continuous /Automatic Selector Switch -

The control switch is used to turn power to the generator on and off and to select the mode of operation desired. Naturally, in the off position there is no power to the unit and the light inside the switch remains off.

When the switch is turned one position to the right (so that it points straight up and down), the 'Continuous' mode has been selected and the unit will cycle regardless of whether or not oxygen is being drawn from the storage tank. The light inside the switch will always be on as well. The advantage to operating in this mode is that oxygen should be available at a slightly higher pressure than if in the automatic mode. How much higher depends on the demand for it. The disadvantage to operating in this mode is that your compressor will run more often.

Turning the switch to the far right position puts the generator in the 'Automatic' mode. In this mode a pressure switch is engaged to sense the oxygen storage tank pressure. Once that pressure reaches about 60 PSIG (420 kPa) the generator will stop cycling. When the pressure in the storage tank falls to about 45 PSIG (310 kPa), the generator will begin to cycle again attempting to refill the storage tank. While in this mode, the light inside the control switch will be on whenever the unit is cycling.

Oxygen Pressure Gauge -

This gauge indicates the pressure of the Oxygen in the storage tank. While this level can vary between 0 PSIG and 65 PSIG (0 kPa and 450 kPa), it should remain between 40 PSIG and 65 PSIG (280 kPa and 450 kPa) during normal operation. The exception, of course, is when the unit is first started and it needs to fill the storage tank. This does not take more than a few minutes.

Oxygen Out -

The Oxygen Outlet Connection is on the right hand side of the machine. There is an appropriately sized fitting to which the GREEN interconnecting Oxygen Hose Assembly should be attached. This Oxygen Hose Assembly has a female threaded fitting that swivels on each end of it. The other side of this Oxygen Hose Assembly should be connected to the inlet fitting of the Oxygen Storage Tank that you are using. If the storage tank was purchased from **OGSI**, it will have an appropriately sized fitting in place for this connection. If the tank was not purchased from **OGSI**, you must insure that it has the appropriate size fitting to accept the hose assembly

Power Cord -

On generators sold within North America, this cord can be plugged into any standard 120 VAC/60 Hz electrical outlet. The generators do not draw much current (less than 1 amp) and have internal protection for short circuiting (either a fuse or circuit breaker depending on which model you have).

Generators shipped outside North America will have an electrical plug suitable for use in the location to which it is shipped or have bare wires ready to accept such a plug. Typically, this will be a three-pronged jack intended to accept a 220 VAC/50 Hz supply but may vary as required.

Manual Drain Switch -

The manual filter bowl drain can be used at any time to empty the contents of the filter bowl and is especially useful during the filter element replacement procedure. It is a momentary switch so it will only hold the drain valve open as long as it is pressed. Upon release, it returns the valve to its normally closed position. This button has a rubber cover protecting it from external contamination. Do not attempt to remove this cover.

Filter Drain Hose -

A small hose is provided with each unit and can be run directly into a drain. This hose will alleviate the potential problem of having water and material trapped by the filter blown directly on to the floor. Using this hose/connection is strictly up to the user.

Relief Valve -

This valve is in place to insure that the oxygen storage tank does not become overpressured. It will only open in the event of a serious malfunction. It is connected to the same tee fitting to which the interconnecting oxygen hose should be attached.

Oxygen Regulator -

If your storage tank came from **OGSI**, there will be an Oxygen Regulator, which you should attach to it. It can be used to set the regulated Oxygen pressure out of the storage tank at any level up to 60 PSIG (420 kPa). Please keep in mind that our specification for the maximum oxygen pressure available from a system is 45 PSIG (310 kPa). Pressures higher than 45 PSIG (310 kPa) will only be available for short periods of time if Oxygen is drawn from the storage tank at or above the specified production rates for the machines. If the demand is for a higher pressure but a lower flow rate or only for a short period of time 60 PSIG (420 kPa) can usually be provided.

Internal Components Drawing

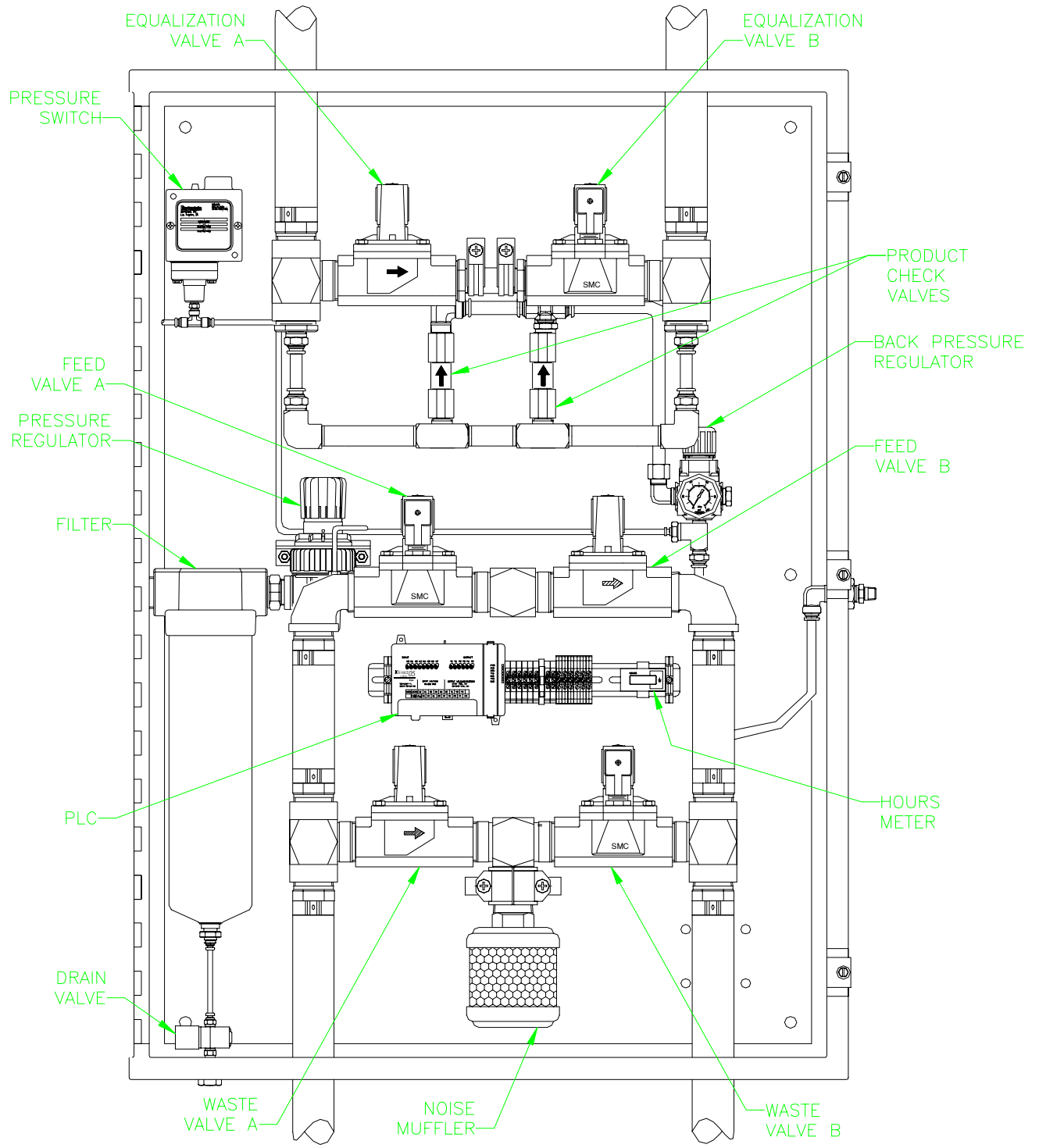

Internal Component Description

Equalization Valve A & B –

The Equalization Valves allow gas to pass between the beds at the end of each pressurization cycle in order to increase the efficiency of the machine by reducing the amount air needed to produce a unit of Oxygen.

Feed Valve A & B –

The Feed Valves allow Air to enter the machine and pressurize the beds beginning the air separation/oxygen generation process. Only one of these valves is open at any point in time.

Waste Valve A & B –

The Waste Valves allow the Nitrogen gas that has been trapped during the previous adsorption cycle to be discharged back to the air. As with the Feed Valves only one of these valves will be open at a time. They operate in conjunction with the opposite side Feed Valve. For example, whenever the Feed Valve on the A side of the machine is open, the Waste Valve on the B side will also be open. The reverse is also true.

Drain Valve –

The Drain Valve allows condensate and waste material trapped in the filter to be discharged automatically at fixed intervals by the PLC or at any time by depressing the Manual Drain button.

Pressure Switch –

The Pressure Switch senses the Oxygen Pressure in the Oxygen Storage Tank and will turn the Oxygen Generator On and Off automatically when it is in the 'Automatic' mode. The Pressure Switch comes set from the factory with a 'Turn Off' point at 60 psig and a 'Turn On' point at 45 psig. Both the dead band (difference between the Turn Off and Turn On points) and the points themselves can be adjusted in the field or by our factory technicians prior to shipment. Please call the factory for assistance in this area if you want to make changes.

Filter –

The filter keeps dust, dirt, and moisture from entering the sieve beds and damaging the sieve.

Pressure Regulator –

The regulator controls the air pressure into the machine. This should be set around 70 psi. Turning it clockwise increases the delivery pressure while turning it counter-clockwise decreases the delivery pressure.

Product Check Valves –

The check valves insure that the oxygen flow stays directed in the right direction by not allowing any back flow through the opposite bed.

PLC –

The PLC (Programmable Logic Controller) controls the operation of the machine and communicates with the touchscreen (on machines equipped with this option).

Hours Meter –

The hours meter increments time while the unit is running. It provides an indication as to when service intervals are due.

Noise Muffler -

The noise muffler is used to silence the exhaust noise that occurs as a result of the sieve beds rapidly depressurizing to atmospheric pressure, venting their nitrogen. For installations where a lower noise level is required, **OGSI** offers an optional alternative muffler system that can decrease the emitted noise even further.

Back Pressure Regulator –

The back pressure regulator controls the flow of oxygen from the machine. Turning it clockwise increases the oxygen flow rate from the machine (while reducing the oxygen concentration). Turning it counter-clockwise decreases the oxygen flow rate from the machine (while increasing the oxygen concentration).

Touchscreen General Introduction

(This is an optional control center and may not be included on your machine)

Before running the Generator be sure to look through the user manual on the follow pages. General information on button usage, and screens is listed below. Please read carefully.

Initially there must be power supplied to the generator. Once there is power to the generator the screen will need to boot up. At first there will be many errors on the bottom of the screen do not worry about the warnings as of yet. As you already know the generator needs to be cycling for at least 15 minutes before it begins to function properly.

Once that phase is over the Language screen will be the first viewable screen. English is the default language, Spanish is available, and French is an option upon request. Any one of these buttons may be pressed as per the language that is appropriate for the user. Once one of these buttons has been selected, and the go to the Security Screen Button has been touched, the Password Screen will be active.

The user must touch the yellow password area, to get a numeric entry system in which the user must enter their password. After the proper password is entered, the next screen will appear. OGSi will supply you with your own password, specified upon your request.

The next screen is the Control Screen. This screen contains the modes of operation, and indicator buttons. For the machine to start cycling one of the Mode of Operation Buttons must be selected, either Continuous or Automatic. There are indicator lights on the screen that are explained above. Once that has been taken care of, you will be ready to move onto the next screen which is the main screen.

The Main screen contains the adjustable pressure switch for the machine. If you are running the Generator in Automatic mode it is possible to adjust the pressure switch. The only way to do this is to deactivate the SET DEFAULT FOR PRESSURE SWITCH. If that touch area reads Off, you may proceed to adjust the Default Pressures. If the area reads On, all that has to be done is to touch the Green Area. Once that has been taken care of the touch area should be red, and the words OFF centered on the button. Note: That the value in SET LOW POINT FOR PRESSURE SWITCH must be less than the value in SET HIGH POINT FOR PRESSURE SWITCH. If this condition does not hold true the machine stops cycling, and errors will begin to pop up. If this error does occur change the Pressure Switch settings immediately. If this is not taken care of immediately the machine will stop cycling. Recommended areas for the Pressure switch is to have a 17 psi difference between high and low points, and the default is 45 (low) psi and 62 (high) psi. There is also a real time clock on this screen, which can be adjusted by 1 hour either up or down.

The next screen is the Gauge Screen, which shows all the gauges of operation. The Regulated Air guage is in psig, the normal variance of this gauge is between 40 (low) and 80 (high) psig. The Waste Gas guage is in psig, the normal variance of this gauge is between 0 (low) and 20 (high) psig. The Oxygen Pressure guage is in psig, the normal variance of this gauge is between 45 (low) and 65 (high) psig. Oxygen Purity is in percent (%), the normal variance of this gauge is between 85 (low) and 98 (high) psig.

The Pressure Screen is the next screen, this screen contains a graph of the 4 gauges over time. Every five minutes a reading is taken. The legend on the bottom of the screen contains the coordinating colors of the meters..

The Alarm Screen contains 7 triggered alarms that only occur when the machine is cycling. These must be ignored when the generator is initially started up because the machine must warm up. The same principle holds true for the alarms on the bottom of the screen. The button that says Touch To View Alarm History, displays the database of the warnings on the bottom of the screen, which tells you to go to the alarm screen, and the triggered errors will be displayed if the machine is cycling.

This Final Screen contains all the general information of the generator, and how to contact OGSi.

USER TOUCH SCREEN

SCREEN 1



If you want ENGLISH as your default language, touch anywhere in the Yellow Area.



If you want SPANISH as your default language, touch anywhere in the Yellow Area.



Once a language has been chosen press this button to advance to the next screen. If you want ENGLISH as your default language, or you have already entered your password, and chosen a default language you may advance to the Password Screen.

SCREEN 2



To initialize the password entry system, touch anywhere in the Yellow Area.

After pressing the Yellow area Numeric Entry System will come up partially overlapping the password area titled Enter Numeric Entry. When this appears enter your numeric password given to you by OGS.

Press Enter to advance to the Next Screen which is the Main Control Screen.

Note: The user will not be allowed to change their default password, so keep it secure!

Note: That once you have entered the Password Screen you can't leave until a proper password has been entered.

SCREEN 3

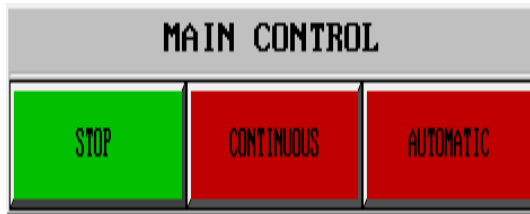

In order to activate the MAIN CONTROL you must chose either CONTINUOUS or AUTOMATIC. Selecting either one will cause the Generator to begin Cycling. To stop the Generator from cycling Press STOP.

NOTE: That whenever the Generator has Power supplied to it the Power Status will Read GENERATOR ON.

If CONTINUOUS is selected, the generator will run in Continuous Mode, in this case the generator will cycle (producing Oxygen) as long as the generator is ON! If the AUTOMATIC is selected, the generator will run in Automatic Mode. This mode allows a pressure switch to be set which can be adjusted on the next screen.

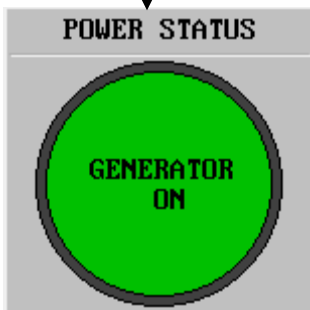

The Indicator Button; POWER STATUS represents the Generator having proper supplied power.

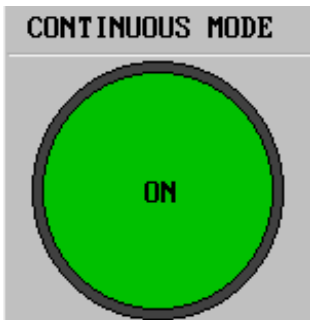

The Indicator Button; CONTINUOUS MODE represents if CONTINUOUS is selected in the main control. If any other option is selected on the MAIN CONTROL Switch CONTINUOUS MODE will read off.

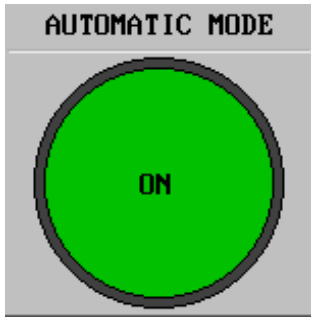

The Indicator Button; AUTOMATIC MODE represents if AUTOMATIC is selected in the main control. If any other option is selected on the MAIN CONTROL Switch AUTOMATIC MODE will read off.

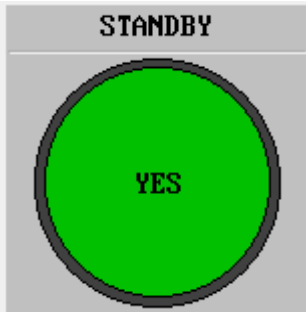

The Indicator Button; STANDBY represents if the Generator is in STANDBY MODE, meaning the Pressure switch has gone active meaning the machine is NOT Cycling, but the Generator is still in Automatic Mode.

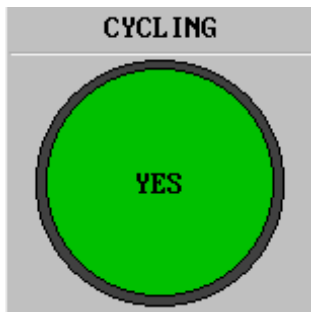

The Indicator Button; CYCLING represents if the generator is cycling, either in Automatic or Continuous Mode.



If you want to go back to the Previous Screen/Password Screen all you have to do is touch the Blue area.

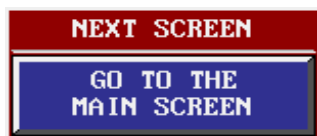

If you want to advance to the Next Screen/Main Screen all you have to do is touch the Blue area.

SCREEN 4



This Switch; SET DEFAULT FOR PRESSURE SWITCH is only for use in the Automatic Mode of Operation. If the button reads ON, the Pressure Switch has its default Pressures placed into SET LOW POINT FOR PRESSURE SWITCH at 45 psi and SET HIGH POINT FOR PRESSURE SWITCH at 62 psi. As long as SET DEFAULT FOR PRESSURE SWITCH indicates being ON the user cannot change the variable Pressure Switch. If you want to adjust the Pressure Switch simply touch the green area so it reads OFF. Once the area reads OFF and the area is red instead of green you may adjust the Pressure Switch according to OGSi specifications.

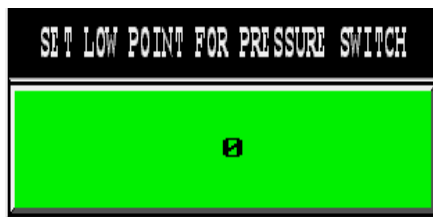

The Button; SET LOW POINT FOR PRESSURE SWITCH allows you to set the LOW point for your Pressure Switch in Automatic Mode. Simply touch any where in the green area, and a numeric keypad will appear to enter the low point. Only 2 digits can be placed into the keypad. Some limitations are in the top right corner of the keypad. Also, do not set the low point greater than the high point. An error will appear and the machine will stop cycling.

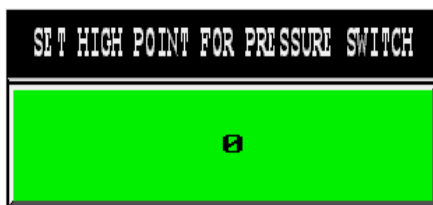

The Buttons; SET HIGH POINT FOR PRESSURE SWITCH allows you to set the HIGH point for your Pressure Switch in Automatic Mode. Simply touch any where in the green area, and a numeric keypad will appear to enter the low point. Only 2 digits can be placed into the keypad. Some limitations are in the top right corner of the keypad. Also, do not set the high point less than the low point. An error will appear and the machine will stop cycling.

Both have ranges from 0 – 70 psi.

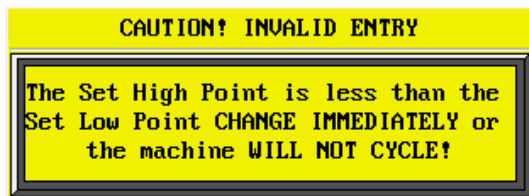

If user enters:
Set Point Low > Set Point High
this warning will appear, and the machine will stop cycling. To get rid of the error just make the proper adjustment.

Warning the machine has run over 4000 or 8000 hours your filters need to be changed.

This alarm is triggered when the machine has run either 4000 and/or 8000 hours. This message will be displayed for 1 cycling hour. So that you will be reminded to change your filters.

HOURS METER
0.0

This Numeric Display; HOURS METER displays the amount of hours that the machine has been running. The HOURS METER is reset at 10,000 hours.

REALTIME CLOCK
02:29:41 PM
23-JUL-01

The Digital Clock; REALTIME CLOCK is a digital display which has default time and date.

TIME ADJUSTMENT
1 HOUR UP

You may adjust the REALTIME CLOCK by increasing it one hour accordingly.

TIME ADJUSTMENT
1 HOUR DOWN

You may adjust the REALTIME CLOCK by decreasing it one hour accordingly.

PREVIOUS SCREEN
GO TO THE CONTROL SCREEN

If you want to go back to the Previous Screen/Control Screen all you have to do is touch the Blue Area.

NEXT SCREEN
GO TO THE GAUGE SCREEN

If you want to advance to the Next Screen/Gauge Screen all you have to do is touch the Blue Area.

SCREEN 5

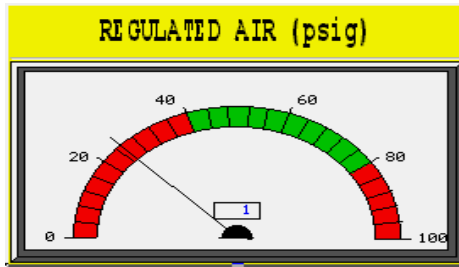

This Meter; REGULATED AIR involves reading your incoming Regulated Air from the compressor. Measurements are in psig, there is both an analog reading and a digital gauge. The digital reading is exact, while the analog meter acts as a real meter. If the dial falls out of the green area an error will appear. The normal operating variance is between 40 and 75 psi.

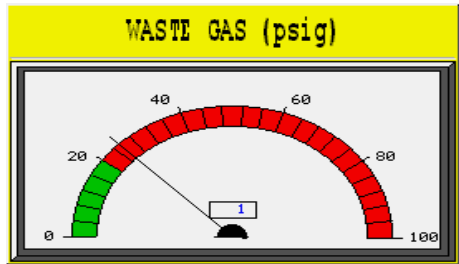

This Meter; WASTE GAS measures the psig of your Waste Gas. The same details hold true for this gauge as in the REGULATED AIR gauge except for the normal operating variance that is between 0 and 20 psi.

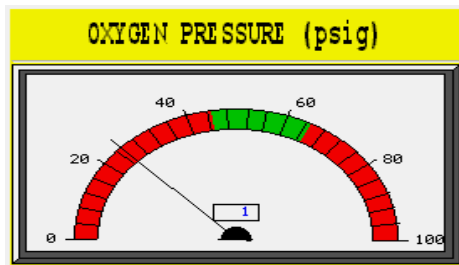

This Meter; OXYGEN PRESSURE measures the Oxygen Pressure (psig) in your back pressure regulator. The same details hold true for this gauge as in the REGULATED AIR gauge except for the normal operating variance which is 45 – 62 psi.

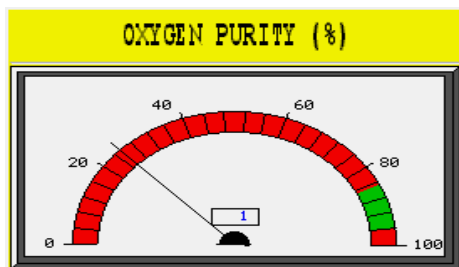

This Meter; OXYGEN PURITY measures the Oxygen Purity that the generator is producing. The same details hold true for this gauge as in the REGULATED AIR gauge except that the Oxygen being generated should be between 85 – 98%.



If you want to go back to the Previous Screen/Main Screen all you have to do is touch the Blue Area.



If you want to advance to the Next Screen/Pressure Screen all you have to do is touch the Blue Area.

SCREEN 6

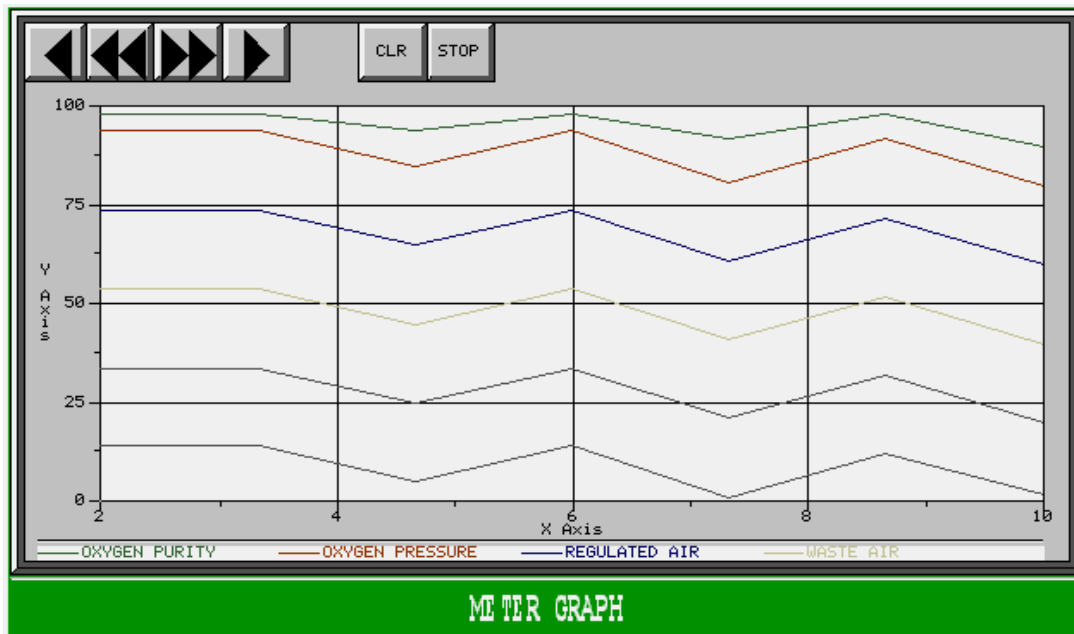

The Line Graph; METER GRAPH displays the activity of the Oxygen Purity, Oxygen Pressure, Waste Gas, and Regulated Air every 5 minutes as long as the generator is on. You can clear the readings, and if the generator is not cycling you can stop the graph from reading. Using the CLR and Stop Buttons. Also you can scroll through the graph using the 4 buttons in the upper left corner.

PREVIOUS SCREEN
GO TO THE GAUGE SCREEN

If you want to go back to the Previous Screen/Gauge Screen all you have to do is touch the Blue Area.

NEXT SCREEN
GO TO THE ALARM SCREEN

If you want to advance to the Next Screen/Alarm Screen all you have to do is touch the Blue Area.

SCREEN 7

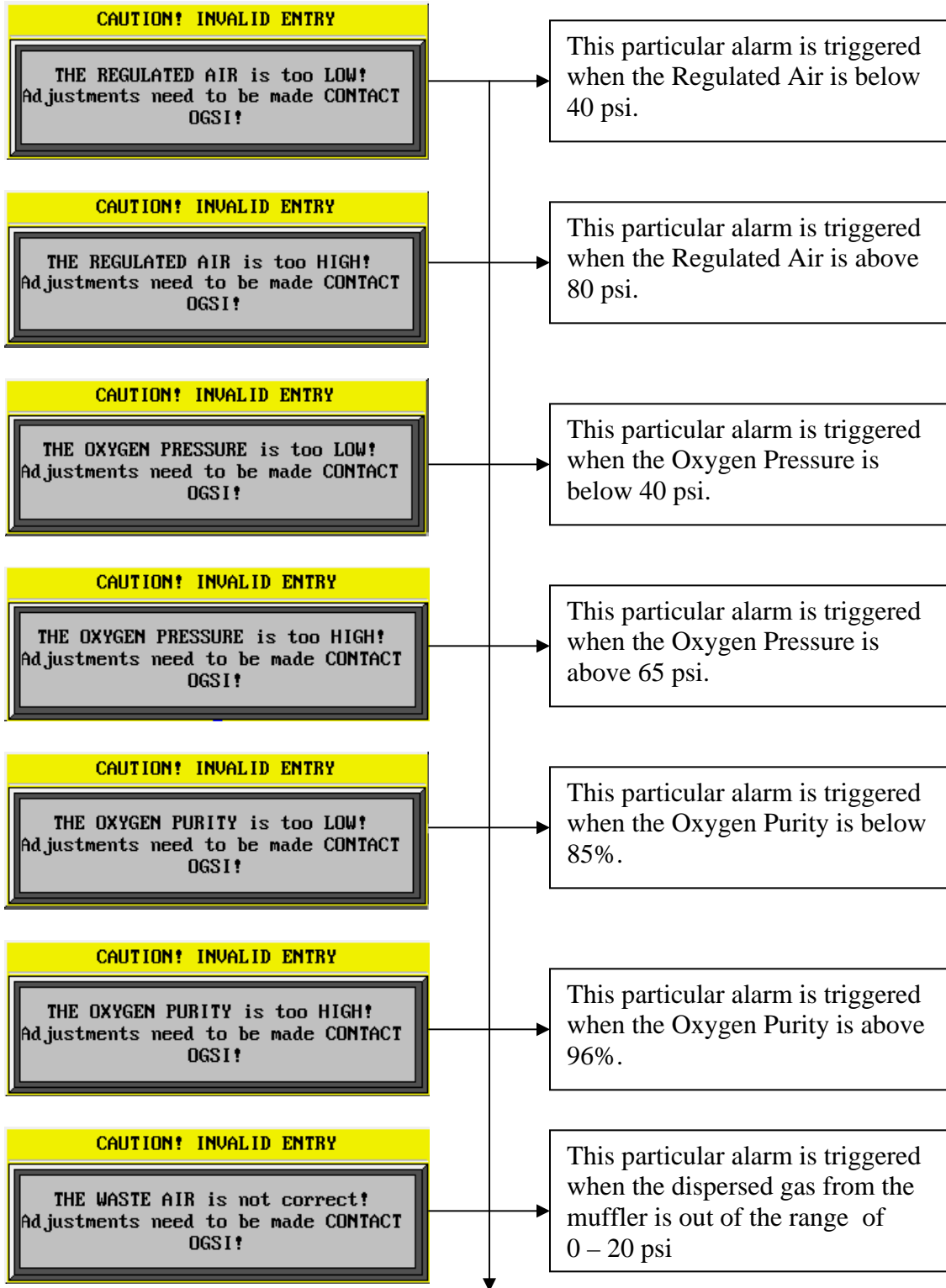

NOTE! These are triggered alarms that will only flash when the machine is cycling. Initially when the generator begins cycling these errors will occur.

Touch To View Alarm History

This button allows you to look at what caused the errors in the system. This is a database of errors.



If you want to go back to the Previous Screen/Pressure Screen all you have to do is touch the Blue Area.



If you want to advance to the Next Screen/Final Screen all you have to do is touch the Blue Area.

SCREEN 8

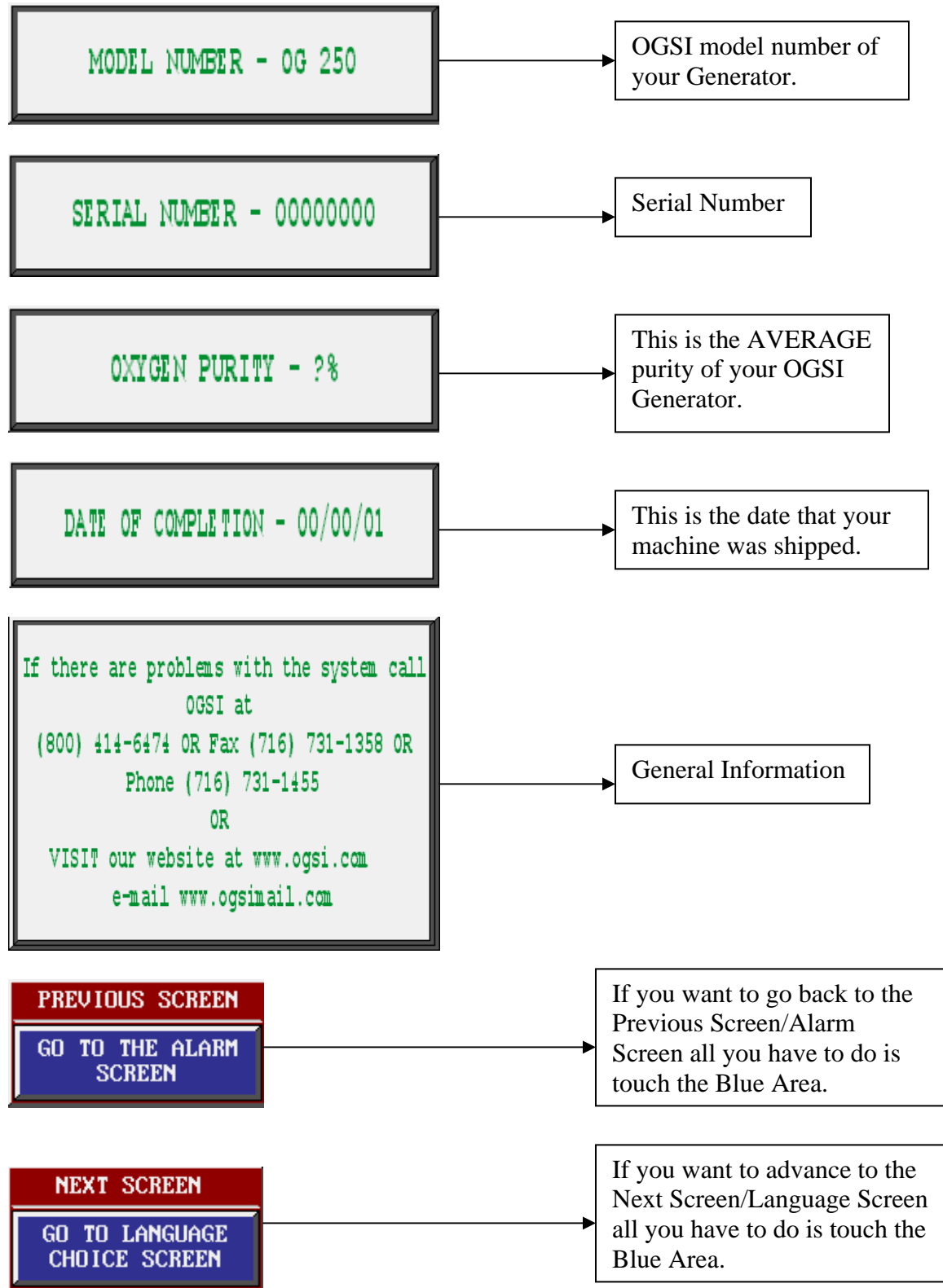

Manifold Drawing

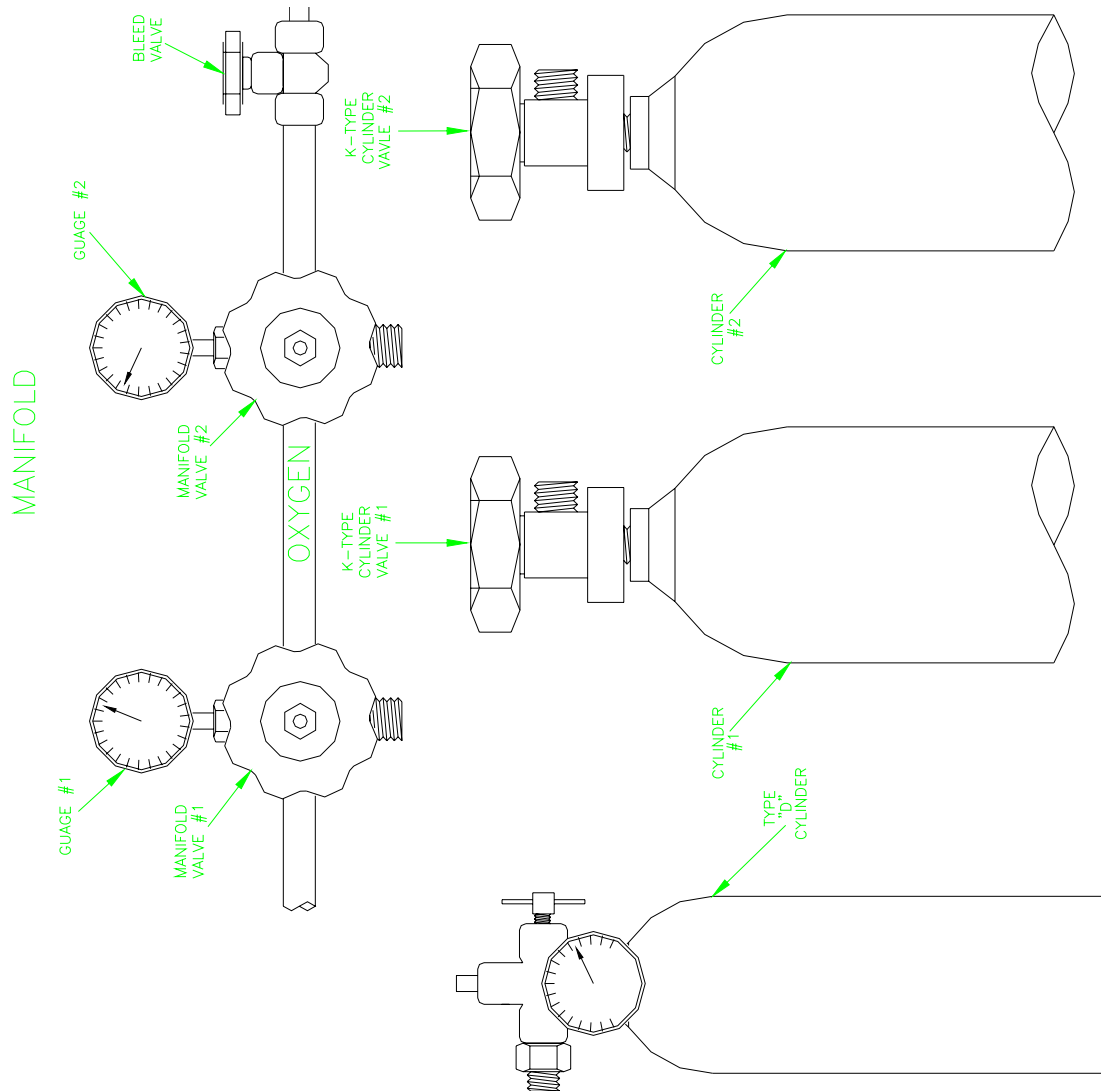

Manifold Operating Procedures

Warning:

High Pressure Oxygen may present a Hazard. Always follow proper operating procedures, and open valves slowly. Rapid pressurization may result in personal injury. Safety glasses and hearing protection are required when venting oxygen under high pressure.

Attaching and filling a K-type cylinder:

With all valves initially closed, connect the steel whip between a manifold valve and a cylinder valve, and tighten both connections using a 1 1/8" wrench. Slowly open the cylinder valve first, and the manifold valve second. Fully open both valves, backing off ¼ turn to prevent the valve from sticking in the open position and appearing closed. At this point, the gauge on the top of the manifold will read the pressure contained within the cylinder. Now, cylinder filling can be initiated by starting the machine, (see start-up procedures).

Detaching a K-type cylinder:

Close each of the appropriate manifold and cylinder valves.

Warning:

Oxygen under high-pressure is present. The use of safety glasses and hearing protection is required. Slowly disconnect the steel whip from the cylinder valve, using a 1 1/8" wrench. Be aware of the venting of oxygen under high pressure. If difficulty is encountered while attempting to remove the steel whip, open the appropriate manifold valve, then slowly open the bleed valve to vent the pressure. This will allow easier removal of the steel whip. Ensure both manifold and bleed valves are closed after venting pressure.

Attaching and filling an M-type cylinder:

It is intended that M-type cylinders be filled from K-type cylinders. With all valves closed, attach the steel whip between the M and K type valves (see Attaching and filling a K-type cylinder outlined above). Slowly open the K-type Cylinder valve, followed by the M-type cylinder valve. Allow pressure to vent from the K-type into the M-type. When the desired pressure is reached in the M-type cylinder, close both valves.

Warning:

Oxygen under high-pressure is present. The use of safety glasses and hearing protection is required. Disconnect the steel whip following the procedure outlined in Detaching a K-type cylinder above.

Routine Maintenance Instructions

Filter Drain:

Make sure the filter drain is working properly and not blocked by anything. When the unit first begins to cycle in the morning the filter drain should open for 5 seconds and then for 5-second periods once every 15 minutes. Do this daily.

Filter Element Replacement:

The filter element provided with the Oxygen Generator must be replaced every six (6) months. The element helps to maintain the quality of the feed air supply and preserve the molecular sieve inside of the oxygen generators. **Failure to replace the filter element on schedule will result in the warranties becoming invalid.**

Cabinet & Power Cord:

The cabinet and power cord should be occasionally washed down with a sponge or clean rag and some soapy water. Avoid the use of ammonia or other strong chemical based cleaning solvents. The intention is to avoid dust and dirt from building up on the machine.

Air Distribution System:

Especially in locations where air is piped over long runs, condensation inside the pipes can be a big problem. The solution is to have traps and drains opened regularly, automatically if practical, to keep the water from reaching your Oxygen Generator

Long Term Maintenance

Air Compressor:

You should consider your air compressor an important part of your Oxygen Generating System and as such maintain it in accordance with the instructions provided in its manual. This will include keeping it properly oiled and changing its filter elements regularly, at a minimum.

The air compressor should last at least two years under normal operating conditions. In many cases it will last five or six years. Eventually, however, it will need to be re-built or replaced. Oxygen purity and flow rate along with feed air pressure delivered to the sieve beds will all be indicators that the air compressor has expended its useful life. Replacement in the field is possible but return of the unit to the factory or an authorized service center is recommended, as by that time a complete maintenance check will be in order.

Valve Replacements:

As with compressor repairs the best practice will be to return the unit to the factory or to an authorized service center for repair.

Filter Element Replacement Instructions

- 1.) Place the Generator in the 'Continuous' Mode
- 2.) Close the Valve that Supplies Air to the Generator
- 3.) Press the Manual Filter Drain Push Button until the Regulated Air Pressure Gauge Reads 0 PSIG
- 4.) Place the Generator in the 'Off' Mode
- 5.) Open the Cabinet Door
- 6.) Disconnect the Plastic Tube from the Brass Prestolok Fitting holding it in Place. This is really the only tricky part in the operation. To disconnect the tube from the fitting the white collar around the tube must be pushed back into the fitting. This releases the tube. It can now be easily pulled out of the fitting. If it is not easy to pull it out of the fitting the collar of the Prestolok fitting is probably not being pushed back into the fitting hard enough. The tube should come out easily once it is released from the fitting.
- 7.) Remove the Filter Bowls by unscrewing the connecting Allen Head Bolts Holding them together.
- 8.) Carefully remove them from the Cabinet
- 9.) Clean out the Inside of the Bowls with Some Soap and Water
- 10.) Remove the Existing Filter Elements by Unscrewing the Units from the upper threads that are holding them in place
- 11.) Insert the New Filter Elements
- 12.) Replace the Filter Bowls
- 13.) Reconnect the Drain Tubes
- 14.) Check to see that the Tube Has Been Replaced Securely By Opening the Valve that Supplies Air to the Generator If the tube blows out of the fitting, close the valve again and go back to step 13
- 15.) Close the Cabinet Door and Begin Operating, If Desired